

# **WISEreader N518**

## **E-Book Reader**

### **User Manual**

---

## *Content*

|                                       |           |
|---------------------------------------|-----------|
| <b>QUICK GUIDE</b> .....              | <b>1</b>  |
| DEVICE BUTTONS .....                  | 1         |
| USING SKILL .....                     | 4         |
| <b>BASIC OPERATION</b> .....          | <b>6</b>  |
| MAIN MENU .....                       | 6         |
| READING INTERFACE .....               | 6         |
| RECENT READING.....                   | 7         |
| BOOK CASE .....                       | 8         |
| PICTURE VIEW.....                     | 11        |
| MUSIC.....                            | 12        |
| NOTES .....                           | 13        |
| HANDWRITING .....                     | 15        |
| SETTINGS .....                        | 17        |
| <b>OTHER OPERATIONS</b> .....         | <b>21</b> |
| BATTERY CHARGING.....                 | 21        |
| FILE MANAGEMENT .....                 | 21        |
| <b>ADOBE READER INSTRUCTION</b> ..... | <b>23</b> |
| FORMAT.....                           | 23        |
| DRM .....                             | 23        |
| STEPS OF SETTING UP DRM .....         | 23        |
| <b>APPENDIX</b> .....                 | <b>25</b> |

---

|                                |    |
|--------------------------------|----|
| TECHNOLOGY SPECIFICATION ..... | 25 |
| CAUTION.....                   | 25 |
| PRODUCT MAINTENANCE.....       | 27 |



## Quick Guide

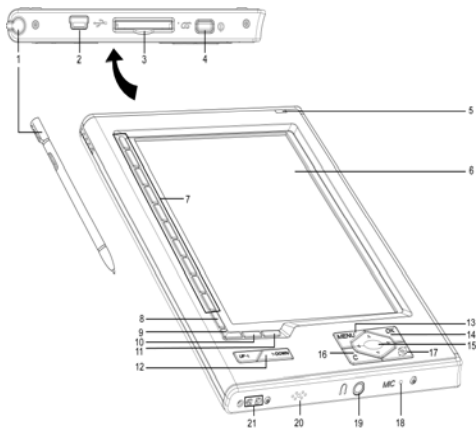

### Device buttons

#### 1) Pen and Pen slot

When the pen is pulled out or inserted into the slot, it will start up or shut down automatically, and the corresponding icon will appear the top of the screen.

#### 2) Mini USB port

USB connection port, it is used for charging the device or transmitting data from PC.

### 3) **SD card slot**

Insert SD storage card into it.

### 4) **Power button**

Press this button to turn on/off the device.

### 5) **LED indicator**

The red indicator will light when the device is charging, and the green indicator will light when the device is operating.

### 6) **Display screen**

### 7) **Number button**

#### **Index button**

Press any number button 1~9 to select and operate the corresponding function at the function menu.

#### **Page jump button**

Under the reading status in DOC, TXT, HTXT, HTML, press the number button 0~9 or any combined number button can jump to the corresponding page directly.

#### **Function shortcut key**

Press “MENU”, the function menu will display. Press any number button to

---

select and operate the corresponding function.

**8) Pen button**

Turn on/off the pen, the corresponding icon will appear on the top of the screen.

**9) Format switch button**

Press this button to switch the display format between portrait and landscape.

**10) Play/record button**

Open or close the “Recorder and Player” interface.

**11) Zoom button**

Press this button to zoom in/out the fonts or pictures.

**12) Page button**

Press this button to turn page up or down. Continue pressing this button can turn ten pages up or down.

**13) MENU button**

Press this button, function menu will display, press direction button or number button to select and operate the corresponding function.

**14) OK button**

Press this button to confirm the operation. Continue pressing “OK” button to lock the keypad, and continue pressing this button again, the keypad will be

unlocked.

### 15) **Direction button**

Press these four buttons to turn page or select option.

### 16) **C button**

Press C button to cancel the operation or return to the previous interface.

### 17) **Refresh button**

Press this button to refresh screen.

### 18) **MIC: Microphone**

### 19) **Earphone outlet**

Plug in/out earphone here.

### 20) **Speaker**

Broadcast voice file.

### 21) **String hole**

## **Using skill**

1. Press “MENU”, and number button “1”, the system can return to the main menu directly. Under the “Recent reading”, “Settings”, “User’s Guide” and “Recorder and Player” interface, press “C” button directly to return to the main menu.
2. Under the reading status, please press “refresh” button to refresh the screen

---

compulsively if the display is not clear.

3. Continue pressing “OK” button to lock the keypad, and continue pressing this button again, the keypad will be unlocked.
4. Under the reading status, press the number button and “OK” to jump to the corresponding page directly.
5. Save power skill: select choose sleep mode; turn off the pen; move the pen far from the screen when the pen is not used.
6. How to set recognition delay time: if the writing speed is slow, please select “long”, on the contrary, please select “short”.
7. It will be faster and safer to use SD card reader to transfer data between PC and device.

## Basic operation

### Main menu

Turn on the device, the main menu will display automatically, as the following picture shown.



### Reading interface

The screen is separated into 3 parts, status area is on the top of the screen; reading and writing area is in the middle; the page information area is at the bottom of the screen.

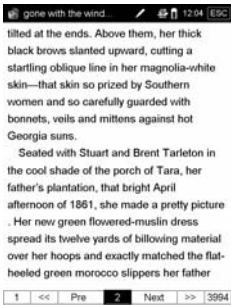

1. Status Area: the menu icon, titles, pen turn on/off, SD card icon, battery, time and “ESC” icon display at this area.
2. Reading and writing area: function list, file list, text or pictures will display at this area.
3. Page information area: display the current page number, total page number, “Previous” and “Next” page button, turn 10 pages up or down button.

## **Recent Reading**

The latest 14 files will display. Press ▲/▼ button to select a book and press OK to confirm, or press the number button to open a book directly. The page you read last time will display when you open this book. If it is the first time you read

this book, it will begin from the very beginning.

**Note:** *If one of the books you read is deleted in the SD card, the reading record will still be remained in the “Recent reading” list, but it cannot be opened.*

## **Book Case**

### **Book reading**

Select “Book Case” and press “OK” step by step to select one book finally, and then press OK to confirm or press the corresponding number button to open the book directly.

### **Page turning**

Press the direction buttons to turn page, you can also press the page button, or click the “page area” with pen.

### **Page jumping**

Under the reading status, press any number button, and then press “OK” to confirm, the book will jump to the corresponding page directly. If there is a mistake, press the direction button to delete the number you’ve input, and input again.

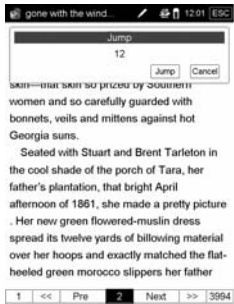

**Note:** If the number you've input is more than the total page number, the system won't accept this operation. Keep pressing the page button up or down for 3 seconds, the book will turn 10 pages up or down once time, this function can't be used in image file.

## Font zoom

Press zoom button to adjust the font size in 3 levels, small, middle and large.

## Format switch

Press format switch button to switch the display format between portrait and landscape.

## Supported format

Support the following format: DOC, TXT, HTXT, PDF, EPUB, HTML.

## Search

Press “MENU” button, select “Search” in the menu, an input frame will display, you could press any number button or write on the screen directly. Then click “Search” to find the content that you want, click “Close” to close the frame.

If you want to search the other content, just click the input frame again to awake it, and input anything you want, and then click “Search”.

## Bookmark

There are two kinds of bookmark: normal bookmark and shift bookmark. Normal bookmark can only be used in one book and can be added 5pcs at most. Shift bookmark can shift books, but before you add a shift bookmark, you need to select “txt” option in “Continuous turning” located in the “Settings”.

**Add a bookmark:** Under the reading status, press “MENU” button, and select “Add bookmark”, a bookmark will be added in the current page.

**View bookmark:** press “MENU” button and select “view Bookmark”, the bookmark list will display. Select a bookmark, the corresponding page will open.

**Note:** *The bookmarks will be sorted by date; only the recent 5 bookmarks can be shown.*

*In the image files, only shift bookmark can be added.*

## Remarks

Under the reading status, use pen to add remark..

**Clean page:** Select “Clean page” in the “MENU”, the remark in this page will be cleaned.

**Clean all:** Select “Clean all” in the menu, all remarks in this book will be cleaned.

**Note:** *Remarks only can be added in the TXT, HTXT and HTML files. If the format and font has been changed, the remarks will disappear.*

## **Picture View**

### **Picture turning**

All pictures saved in the folder can be browsed continuously.

### **Picture view**

There are four display modes for viewing the pictures: Fit Window, Fit Width, Fit Height and Actual Size. It also can be adjusted by  zoom button.

### **Format switch**

Press format switch button to switch the display format between portrait and landscape.

### **Supported format**

Support the following format: JPG, BMP, GIF, TIF and PNG.

## Picture size

Support 3,000,000 pixels in maximum.

## Music

There are two functions in this option: record and play.

### Play music

Select “Music” in the main menu, and press “OK”, the music list will display, and press “OK” or “Play/record” button to open the “Recorder and Player” interface.

Support the following format: mp3, wav, wma.

### Play record

Press “Play/record” button to enter the “recorder and player” interface, click “Rec” to record, the recording file will save at E-audio folder, which format is wav.

Click “play” or press the number key “1” to play this recording file.



## Recorder settings



**Play/Pause:** Press the number button “1” to play/pause music or record, and a speaker icon will appear at the status area.

**Record:** Press the number button “2” to record, and a microphone icon will appear at the status area.

**Stop:** Press the number button “3” to stop music or record.

**Forward/Rewind:** “Forward” and “Rewind” functions are implemented by the number button “4” and “5”.

**Single/Cycle:** These two playing modes are implemented by the number key “6”.

**VOL+/-:** Press the direction button  /  to decrease or increase the volume.

**Pre/Next:** Press the direction button  /  to select the previous or next music.

## Notes

Select “Notes” in the main menu to enter the “Note” interface.

### Note

Click  in the “Note” interface, the remark can be made using pen and remain on the screen.

Click , and draw a cross on the character you've written, that character will be cleared.

Click , all remarks on the screen will be cleaned.



Click , this note will be deleted.





## Text

Click Text to enter the “Text” interface. Click anywhere on the screen, the input area will display, write any words in this area, the character will be recognized and displayed on the screen.

Click , the input area will disappear. Click anywhere on the screen again, the input area will display.

Click , the input area will display on the top of the screen, click , the input area will display at the bottom of the screen.

Click , all marks on the screen will be cleared.



Click , this txt will be deleted.

**Note:** Please click “←” in the input area to delete a character.

## Handwriting

The system supports handwriting, drawing and making remarks in the Notes and Bookcase (which formats are TXT, HTXT, HTML).

### Switch input method

Click , can switch the input method to “Keypad” inputting. Click , can switch the input method to “handwriting”.



### Word Recognition

Under the English Mode, the English word you've written in the input area

can be recognized and there is also some candidate words appeared in the input area.

**Note:** *Please keep close between the letters in one word, and leave space between the words.*

### Number string recognition

Under the Number Mode, number, number strings and some symbols can be recognized, i.e. telephone number, math formula and number plus symbols.

### Secondary Function

**Candidate words:** If the word recognized wrong, please choose the right word in the candidate words area.

**Associated words:** In the input area, the associated words will appear. You could select the right word directly. Click the arrow buttons located at the side of the input area will get more associated words.

**Handwriting sign:** There are some signs for controlling the handwriting.

Tab: Input tabs.

Space: Input a space.

Backspace “←” : Delete the previous character.

Enter “↵” : Enter a new line.

### Input method

Under the default status, input English and symbols; select “123...” to input number and some symbols; select “?” to input “?”, select “@” to input “@”.

## **Settings**

Select “Settings” in the main menu, and press “OK” to enter the interface. Press the direction button to select the corresponding option, and you also can press the number button or click the option to select the function.

### **Continuous turning**

Including picture, html, txt, all files saved in one folder can be browsed continuously.

### **Handwriting input**

**Recog delay:** there are three levels for recognition time delay: short, middle, long. Select “Short”, the recognition delay will be short; select “Long”, the recognition delay time will get longer.

**Line thickness:** there are three options for the line thickness: thin, normal, thick. That function can't be used in remarks and notes.

### **Sleep Settings**

**Sleep:** Select “Yes”, the system will sleep after 3 seconds if there isn't any operation on the device, the LED indicator will turn off; select “No”, the system

won't sleep, and the LED indicator will always light. The system won't sleep in below option: "Music".

**Sleep Delay:** There are three levels can be selected: short, middle, long. Select "short", the system will get into sleeping mode quickly; select "long", the system will get into sleeping mode slowly.

### Recent Reading

**Select "Record":** Save the reading records.

**Select "Not Recorded":** The system will not save the reading records.

**Clean up:** The recent reading records will clean up.

### Key-press/Pen-touch sound

Select "on" or "off" to turn on or off key-press/pen-touch sound.

### Reading Voice

There are some options for reading voice, such as male voice and female voice.

### Font settings

There are two effects for displaying font: Clear and Smooth.

### System time

Display the current date and time in the system.

**Modify time:** Click "Modify time", or press the direction button to select

“System time”, and press the number button “1” to open “Modify time” interface, and press the number button directly to input time, and then click “OK” to save the new time. Click “Cancel”, the new time will not be saved.

### **Refresh mode**

There are two refresh modes in the system: Part and Global.

**Part refresh:** Part screen will be refreshed.

**Global refresh:** The whole screen will be refreshed. Under the direct sunlight or low temperature, global refresh is recommended.

### **Factory default**

**Default:** Restore the system to the default settings. Please save all data on the SD card before you restore the system.

**Clear temp:** Clear the temporary files in the system. This function can't be used very often. If the system space getting smaller or the performance getting worse, please operate this function. After that, all previous bookmarks will clear up; the book will be opened from the very beginning.

**Clear remark:** All remarks will be cleared.

### **System Update**

Download the update package, decompress the package and save it under the root directory in SD card, select “Update”, the system will operate the software

---

updating automatically. ((Be careful to operate this function, and please refer to the cautions in appendix))

### **Device information**

Display the device ID and version information in this option.

**Device ID:** With the device ID, you could get our support after sale, including technical services and more legal E-books resources and reading authority, and so on.

## Other operations

### Battery charging

Please charge the battery when it run out. The device can be charged through USB data wire or charger (selective accessory)

There are two ways to charge the battery, power-on charging and power-off charging.

Connect the device to the computer with a USB plug data wire. The red LED indicator will light; the battery icon in the status bar will indicate the battery is charging.

**Note:** *The charging time is about 4 hours. The red LED indicator will be off when charging is finished. It's better to charge the battery when the hint screen disappears, and please ensure the battery is fully charged. This will extend the Lithium battery life.*

### File Management

#### **Connected to computer**

Connect the device to the computer with the USB data wire. Turn on the device, “Are you sure to transmit data?” will display on the screen. Press “OK” to confirm. The computer will automatically detect a new storage device connecting.

---

## Files management

Select “removing disk” in “My computer”, you could remove, copy or delete the files or folders. At that moment, your E-book reader is under the locked status.

Under the default status, there are several pre-store folders in the SD card: Recent reading, Bookcase, Picture View, Music, save the files in the corresponding folder respectively.

**Note:** *These pre-stored folders can't be renamed or deleted, and please save the files in the right folder, otherwise, the files won't be opened, for example, save TXT, HTXT, PDF, EPUB, DOC, HTML files into “Book Case”, save pictures into “Picture View” and save music into “Music”.*

## Adobe reader instruction

### Format

Support PDF and EPUB files

### DRM

1. Adobe DRM protected PDF and EPUB file is supported only if Adobe Digital Editions 1.5 or later is installed on your computer and your WISereader is connected r to the computer.

#### 2. Digital Rights

Displays the following only if a book with DRM is selected.

- a. Full viewable: the entire book can be read.
- b. Restricted: Some or all of the book cannot be read.

#### 3. Expiration date

Displays the expiration date of a book if the book with DRM has an expiration date.

### Steps of setting up DRM

Step 1. Install the Adobe Digital Edition on your computer.

Step 2. After installation, open the above software, and enter your Adobe account

---

(which should be applied at beginning).

Step 3. After turning on the WISereader, (click on “Set DRM” which is included in the “Settings” interface. Please ignore this item if you cannot find it). Then, keep the Adobe Digital Edition open, and connect the WISereader to the computer, there will show a window for activation. Click on “Authorization”, then DRM activation is completed.

**Notes:**

- 1. The authorization information is stored in SD card. Thus, you need to active the device again if using a new SD card.*
- 2. After activated, if you want to use a new account to active, please delete the hidden folder under SD root: “.adobe-digital-editions”.*

Please refer to below website for more information.

<http://www.adobe.com/products/digitaleditions>

## Appendix

### Technology Specification

|                              |   |
|------------------------------|---|
| <b>Size</b>                  | 153×112×12mm  |
| <b>Screen</b>                | 5" Electronic Paper Display (EPD); 8-level gray scale; Ratio 4:3; Pixel resolution: 800×600 |
| <b>Weight</b>                | 190g(Net)   |
| <b>Storage device</b>        | Expanded SD card (32GB in maximum)  |
| <b>Power supply</b>          | internal Lithium battery 1500mAh; USB Charge  |
| <b>Operating temperature</b> | 0°C~40°C, 32°F~104°F  |
| <b>Storing temperature</b>   | -20°C~55°C, -4°F~113°F  |

### Caution

#### About SD card

If SD card can't be recognized for a long time, you can plug in the SD card again or restart the device. When the system is reading data, please do not remove the SD card or reset the system.



If SD card needs to be formatted, please backup all data in SD card first, and

then select FAT-32 format.

### **Restart the device**

1. When the device is crash or freeze, click the “RESET” hole located at the back of device to restart the system.
2. When the power run out and device can not be turned on, please charge the device.

### **Pen can't be used**

1. Please check whether the pen is turn-on (Please check the pen icon at the status area) .
2. In a Note, please be sure “” is selected, not “” or anything else.
3. The system will sleep if the pen is staying on the top of screen for a long time. Take away the pen from screen, and go back to the screen, the pen will be awaked.
4. Be sure the pen is not damaged.

### **Others**

1. Under the direct sunlight or low-temperature environment, the characters displayed on the screen would be fading, please enter “Settings” interface and select “Global” to refresh the whole screen.
2. Due to the limitation of memory, some complex DOC, PDF and HTML files can't be decoded by the device.

3. The display format can't be switched in the following interfaces: "Recorder and player", "Settings", "Notes" and any menus.
4. Prevent impaired hearing  
By using earphone for a long time, high volume will damage the hearing. Please adjust the volume at a lower level before using the earphone.
5. Technology service: tech@hanvon.com
6. Web site: <http://www.hanvon.com>.

## **Product maintenance**

### **Software upgrade**

Please download the legal upgrade package from Hanvon website. Copy "Update.bin" and "Update.cde" to the root directory of SD card.

Click "Settings" in the main menu, and select "System update", then press number button "1" or click "Update". The hint information "Are you sure to update system?" will pop-up. Click "OK" to confirm, the system will update automatically.

**Note:** *During the update period, please be sure the battery is not in low power status. After that, the system will restart and enter the main menu automatically. If the updating procedure is interrupted, there will be an error for the system.*

### **Operating environment**

The operating temperature for this device is from 0°C to 40°C (from 32°F to 104°F). The performance will get worse, if the operating temperature extend this range. Please avoid using this device under the direct sunlight, in damp and dust place. In very cold areas, please avoid using this device outside in the winter.

### **Keep clear of the slot**

The slots of the device is used for heat output, please keep clear of the slot.

### **Safety**

The parts in this device are friable; please prevent the device from dropping, smashing, bending and high pressure.

Please don't read during driving and riding.

### **Cleaning**

Don't clean the device when it is power-on or charging.

Please use soft cloth or the other similar material (except cotton) to clean the screen and faceplate;

The foam, solvent, water, alcohol and the other cleanser (or spray cleanser) are forbidden.